



# HORIZON VHA 112SA

Vertical Horizontal Array Active Subwoofer

FBT elettronica SpA

Via Paolo Soprani 1 - 62019 RECANATI - ITALY Tel. 071 750591 - Fax. 071 7505920 - email: info@fbt.it - www.fbt.it

## APPLICATIONS

- Touring sound reinforcement
- Theatres, Stadiums, Concert Halls, Arenas.....
- Ideal for reinforcing and extending the low range of the HORIZON VHA system

## FEATURES

- Self powered bass-reflex LF cabinet
- 1200W RMS Class D amplifier
- DSP processor with 8 presets
- Cabinet in 0,47" birch plywood with anti-scratch varnish
- Rubber-coated sides
- Possibility of vertical and horizontal installation through dedicated flybars
- Wide range of accessories for suspension, pole-mounting, ground-stacking
- Completely Manufactured in Italy

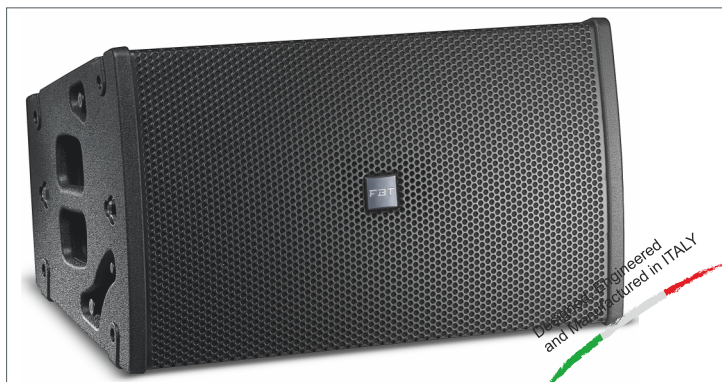

COLORS AVAILABLE BLACK



## DESCRIPTION

The FBT HORIZON VHA 112SA speaker is a self-powered line array LF extension module. The FBT HORIZON VHA 112SA is suitable for high-power extended bass response applications with VHA 406A cabinet in arenas, theatres, stadiums, concert halls, houses of worship, etc. The FBT HORIZON VHA 112SA features a 12" high-excursion custom B&C woofer with 3" voice coil. The Class D amplifier module is constructed in die-cast aluminum with natural convection to deliver 1200W RMS. The FBT HORIZON VHA 112SA offers the possibility to choose between 8 pre-defined algorithms; the controls and connection panel features: Neutrik powercon connector for power supply with input and output, XLR input and link connectors, level control, preset selector, delay, "Low extension" switch, two status led. The cabinet is moulded on 0,47" birch plywood with anti-scratch varnish and is provided with two handles, rubber inserts and integrated mechanics to join the speakers and angle them from 5° to 20° in 5° steps. The FBT HORIZON VHA 112SA has the same dimensions and the same suspension mechanics integrated in the VHA 406A model that allow the realization of configurations in vertical / horizontal array or ground stack in combination with the VSA 118SA subwoofer with the same performances of a 3-way. The front of the loudspeaker is covered with a powder coated perforated steel grille. Available a rain cover that protects the electronic parts from the rain.

## PERFORMANCE

System Type	1 way bass-reflex subwoofer
Built-in Amplifier	max.: 1200W RMS max. peak.: 2400W
Frequency Response @ -6dB	50Hz - preset dependent
Input Impedance	22kOhm
Maximum SPL ( cont/peak ) *	131,5/135dB half space
Dispersion	omnidirectional
Crossover Frequency	preset dependant
Power consumption	640 W
Nominal power requirement	220 - 230Vac 50/60Hz

## PHYSICAL

Low Frequency Woofer	1 x 12" - 3" coil
Input Connectors	1 male + 1 female XLR IN/LINK
Net Dimensions (WxHxD)	24,1" x 14,2" x 15,6" 612 x 360 x 397mm
Shipping Dimensions (WxHxD)	28,34" x 16,14" x 20,27" 720 x 410 x 515
Net Weight	57,32 lbs / 26 kg
Shipping Weight	61,72 lbs / 28 kg
Enclosure Material	0,47" birch plywood
Power cord	16,40 ft / 5 mt.

\* CONT SPL: half space, based on power amp rating and LF transducer average sensitivity data, 125mS time average  
PEAK SPL: half space, based on peak power amp rating and system peak sensitivity, 10mS time average



# HORIZON VHA 112SA

Vertical Horizontal Array Active Subwoofer

FBT elettronica SpA

Via Paolo Soprani 1 - 62019 RECANATI - ITALY Tel. 071 750591 - Fax. 071 7505920 - email: info@fbt.it - www.fbt.it

## CONNECTION PANEL

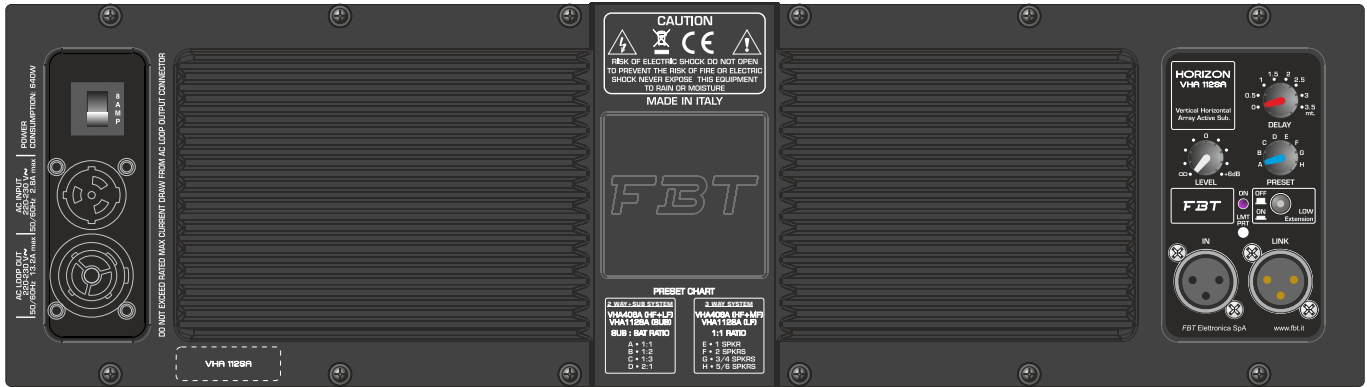

## AMPLIFIER MODULE

The HORIZON VHA 112SA provides a high-efficiency Class D power amplifier module with switching power supply enclosed in a die-cast aluminium chassis. This permits to protect the electronics against dust, avoid any air loss through the controls – which would cause annoying noises- and maximize heat loss by using the woofer ventilation instead of a cooling fan.

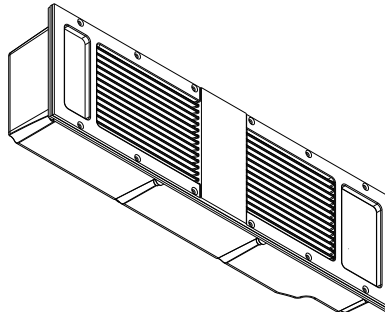

## DIMENSIONAL DRAWING

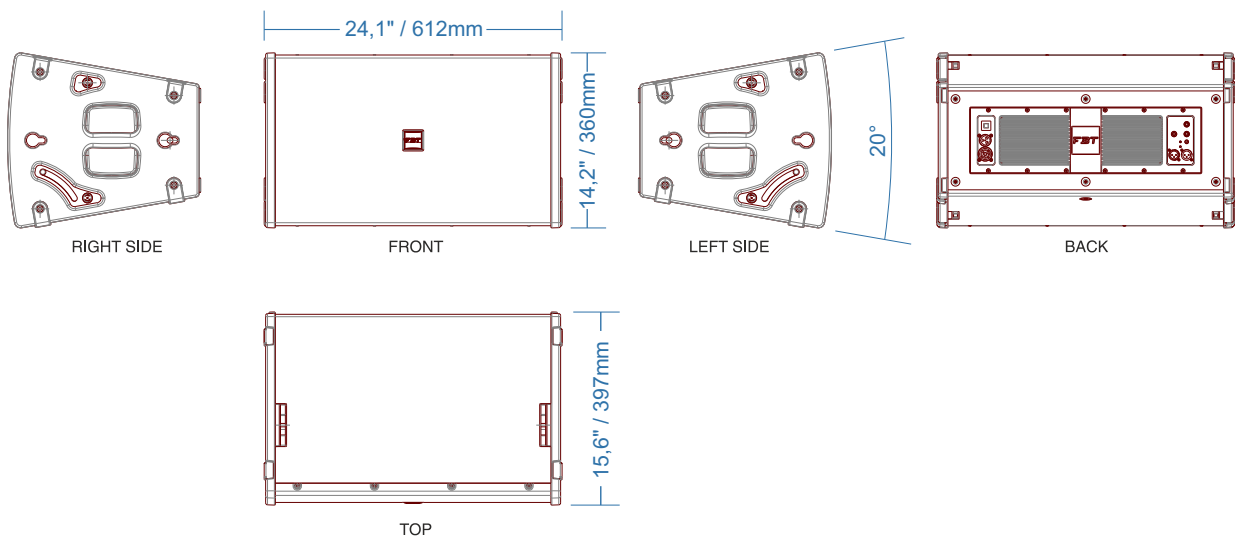



# HORIZON VHA 112SA

Vertical Horizontal Array Active Subwoofer

FBT elettronica SpA

Via Paolo Soprani 1 - 62019 RECANATI - ITALY Tel. 071 750591 - Fax. 071 7505920 - email: info@fbt.it - www.fbt.it

## ACCESSORIES

### VHA-S 406

CLUSTER BRACKET WITH SPEAKER POLE

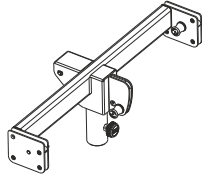

### VHA-FH 406-1

HORIZONTAL FLYBAR 1 SPEAKER

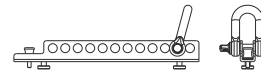

### VHA-F 406

VERTICAL FLYBAR

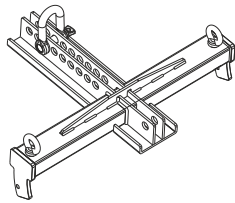

### VHA-RC 406

RAIN COVER

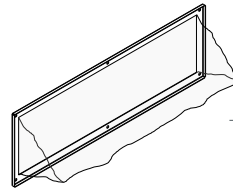

### VHA-B 406

BASE TO GROUND ARRAY OR STACK ON SUB

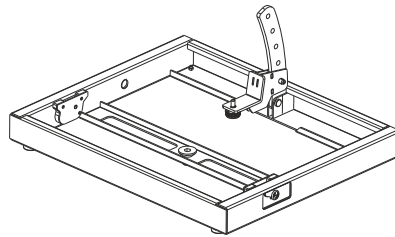

### VHA-FH 406-5

HORIZONTAL FLYBAR 5 SPEAKERS

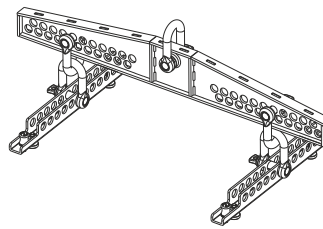

### VHA-T 406

TROLLEY WITH STABILIZER FEET

